

Varenummer: 204380M20100D3V

Beskrivelse: E+G Justerfod  
GN 43-80-M20-100-D3-V

Note: V Uden møtrik, udvendig sekskant i toppen, spændeflade i bunden

## Mål

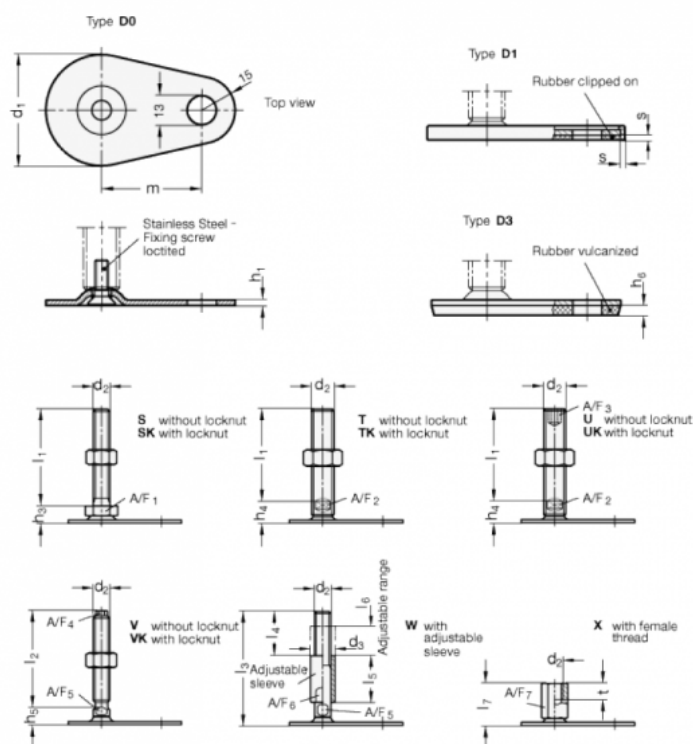

A/F4 = 13	m = 70
A/F5 = 16	s =
d1 = 80	
d2 = M20	
h1 = 3	
h5 = 15	
h6 = 5	
l2 = 100	